

# S-121 SELECTORIZED SEATED ROW

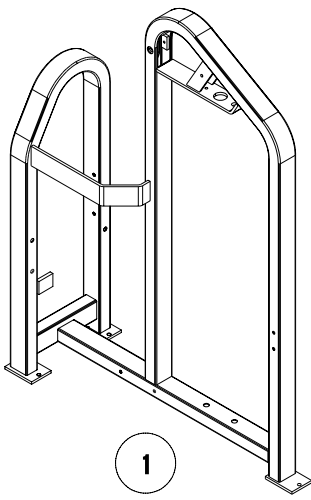

1

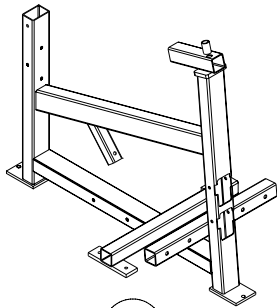

2

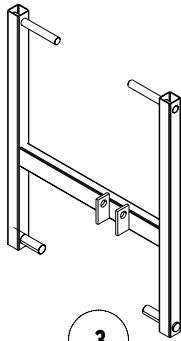

3

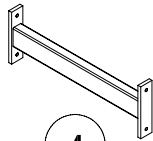

4

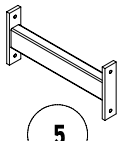

5

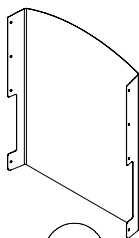

6

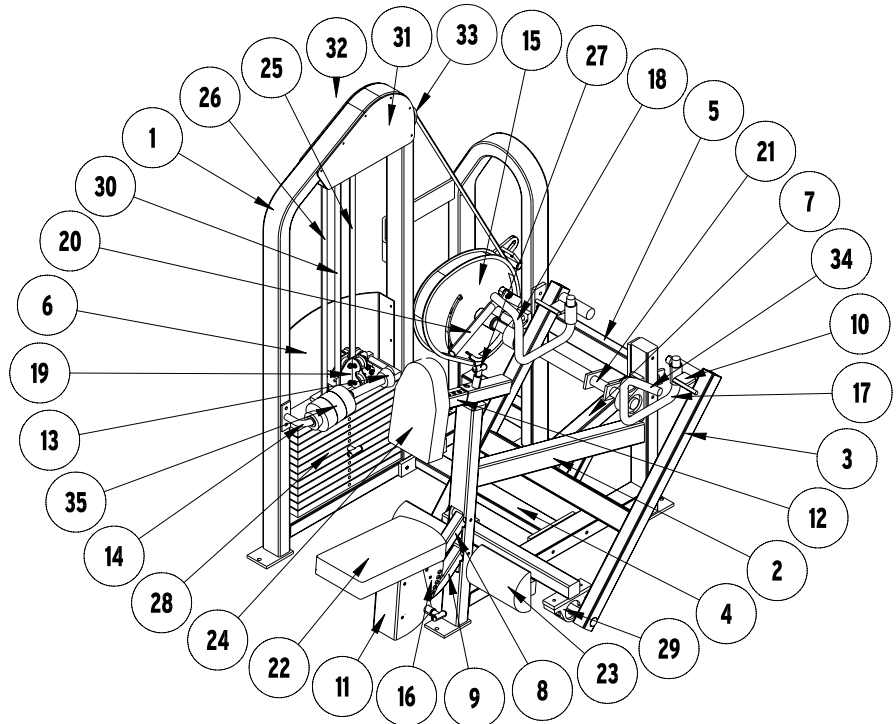

ITEM	PART DESCRIPTION	QT	ITEM	PART DESCRIPTION	QT	ITEM	PART DESCRIPTION	QT
1	WELD,FRM,WEIGHT S-121	1	14	ASSY,ADD-ON HOLDER,WFD	1	27	ASSY,POPPER PIN,0.5x1.5	2
2	WELD,FRM,EXERCISE S-121	1	15	ASSY,CAM,BELT,LRG,STD	1	28	ASSY,WGHT,20# STANDARD, 4x19	12
3	WELD,ARM,EXERCISE S-121	1	16	PLATE,RANGE,SEAT,STAINLESS	1	29	BEAR,PILLOW,1.25 ID	4
4	WELD,CROSS BRACE 23.5	1	17	WELD,HANDLE(R) P/S-104/21	1	30	BELT,FLAT,0.094x1x108"	1
5	WELD,CROSS BRACE 17.5	1	18	WELD,HANDLE(L) P/S-104/21	1	31	DECAL,INSTRUCTIONAL,S-121	1
6	BENT,SHT,WEIGHT SHIELD	1	19	ASSY,TOP PLATE,12 STEM	1	32	DECAL,LOGO,STRIVE,LEFT	1
7	WELD,LINK S-121	1	20	ASSY,HANDLE,CAM,DOWN	1	33	PULLEY,BELT,0.38 IDx4.5 OD BLK	2
8	WELD,LINK,SEAT,TOP LEFT	1	21	WELD,LINK,CAM S-121	1	34	RUB,GRIP,1.05 IDx16 BLK	2
9	WELD,LINK,SEAT,BOT LEFT	1	22	UPH,PAD,SEAT/BACK 8.25x16.25	1	35	WGHT,5#ADDON,4.75 ODx1.75BLK	3
10	ASSY,UNIVERSAL P/S-121	2	23	UPH,PAD,HALF MOON 6x8.5	2			
11	WELD,SEAT,S/K-128 S-121	1	24	UPH,PAD,SEAT/CHEST 7.25x12.7	1			
12	WELD,ADJ,CHEST P/S-121/S/K-128	1	25	*CP075 ,TAPPED ,49.50*	1			
13	ASSY,ADD-ON HOLDER,TPD	1	26	*CP075 ,GROOVED ,49.50*	1			

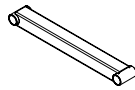

7

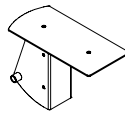

11

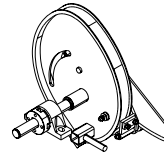

15

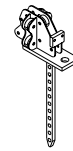

19



23



8

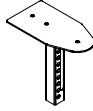

12



16

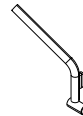

20

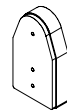

24



9



13



17

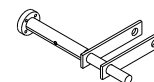

21



10



14



18

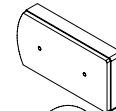

22