

S-129 SELECTORIZED PEC/REAR DELT

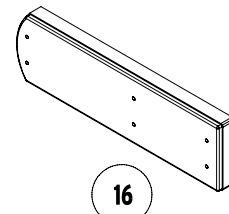
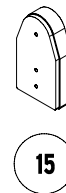
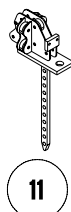
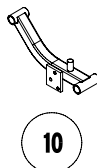
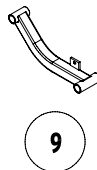
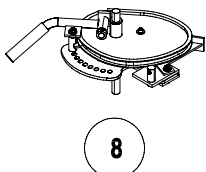
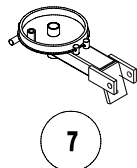
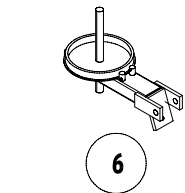
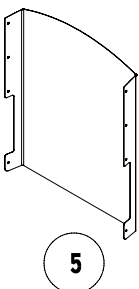
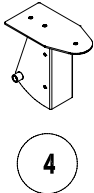
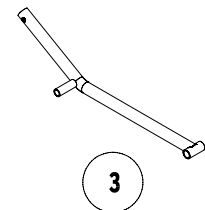
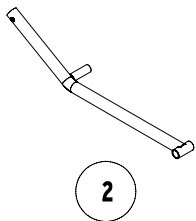
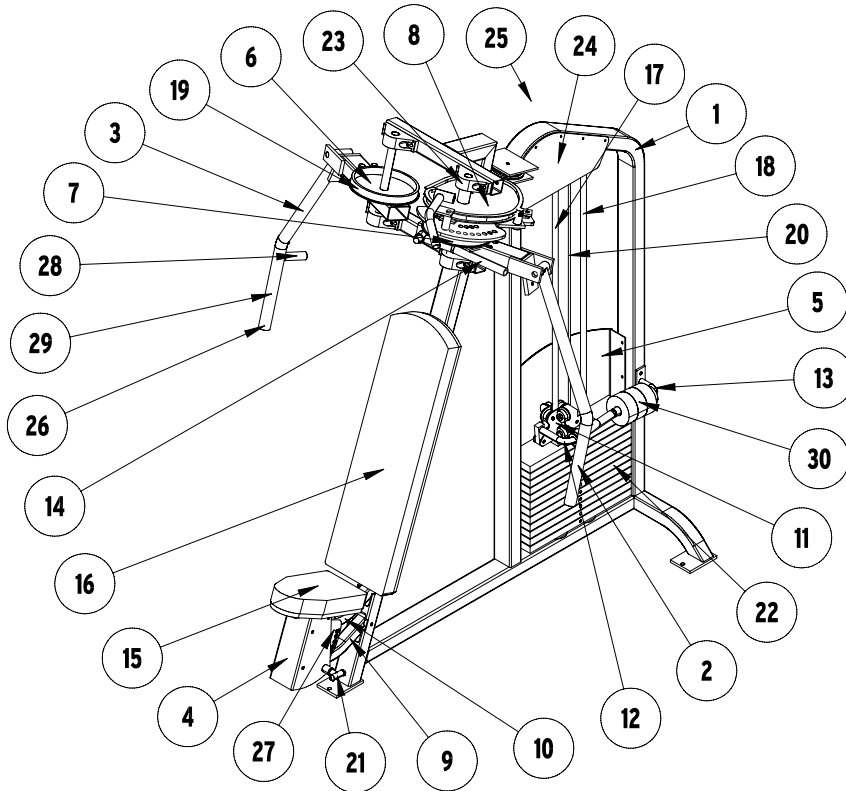
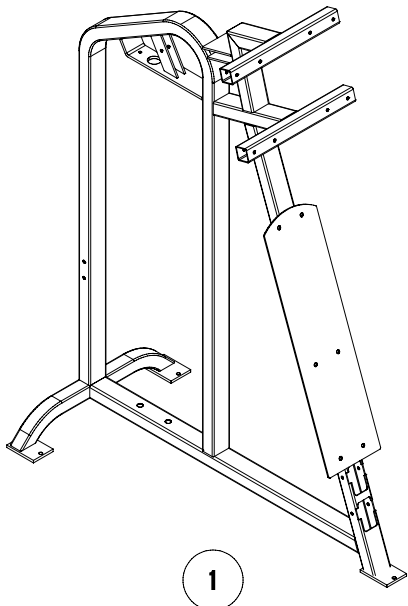

ITEM	PART DESCRIPTION	QT	ITEM	PART DESCRIPTION	QT	ITEM	PART DESCRIPTION	QT
1	WELD,FRM,WEIGHT S-129	1	13	ASSY,ADD-ON HOLDER,WFU	1	25	DECAL,LOGO,STRIVE,RIGHT	1
2	WELD,HANDLE,EXERCISE S-129 L	1	14	ASSY,HANDLE,ARM S-129	1	26	PLAS,WHEEL,0.5 IDx3.00 OD	2
3	WELD,HANDLE,EXERCISE S-129 R	1	15	UPH,PAD,SEAT/CHEST 7.25x12.75	1	27	PLATE,RANGE,SEAT,STAINLESS	1
4	WELD,SEAT,S/K-02/03/29 S-20/17	1	16	UPH,PAD,BACK 10.25X36.25	1	28	RUB,GRIP,1.05 IDx3 BLK	2
5	BENT,SHT,WEIGHT SHIELD	1	17	*CP075 ,TAPPED , 55.50*	1	29	RUB,GRIP,1.50 IDx8.5	2
6	WELD,ARM,EXERCISE S-129 R	1	18	*CP075 ,GROOVED , 55.50*	1	30	WGHT,5#ADDON,4.75 ODx1.75BLK	3
7	WELD,ARM,EXERCISE S-129 L	1	19	ASSY,CABLE,W/STUDS.1/8 WDX34	2			
8	ASSY,CAM,S-129	1	20	ASSY,CABLE,W/STUDS.1/8 WDX72	1			
9	WELD,LINK,SEAT,BOT LEFT	1	21	ASSY,POPPER PIN,0.5x1.5	1			
10	WELD,LINK,SEAT,TOP LEFT	1	22	ASSY,WGHT,20# STANDARD, 4x19	12			
11	ASSY,TOP PLATE,12 STEM	1	23	BEAR,PILLOW,NYLON,1 ID BLK	4			
12	ASSY,ADD-ON HOLDER,TPU	1	24	DECAL,INSTRUCTIONAL,S-129 WH	1			